Product Specifications

Type : MS Lithium Rechargeable Battery

Model : MS518SE FL35E

This is a "Standard Spec sheet " which is a general documentation for your evaluation.

Before we will start to supply this part to you, we would like you to ask us the formal version of this spec sheet.

We will issue the formal specification sheet for you.

(Basically the contents is the same as this one.)

We would like you to put your signature on it to state your approval of the specification, and send it back to us.

Seller: **Seiko Instruments Inc.**
Electronic Components Sales Head Office

History of Revision

No.	Details of Change	Issue Date
01	Initial Release for Standard specifications	August.27.2018

Manufacturer information

Company name: **Seiko Instruments Inc.**

Micro-Energy Division

Address: 45-1, Aza-Matsubara, Kami-ayashi, Aoba-ku, Sendai-shi,
Miyagi, Japan, postal code: 989-3124

Index

Contents	page
Cover page	1
History of revision Manufacturer Information	2
Index	3
1. Application	4
2. Model	4
3. Chemical System and Structure	4
4. Nominal Specifications	4
5. Characteristics Electric characteristics Mechanical characteristics Reliability Parameter	5
6. Measuring Methods	7
7. Test Methods	8
8. Mounting Methods	9
9. Indications(Markings)	9
10. Inspection	10
11. Package Specifications	10
12. In case of quality trouble	10
13. Operation of this Specification	10

Appendix

Leakage Criteria
 Construction of Battery
 Battery Drawing with tabs
 Drawing of tray
 Package specifications
 Precautions for Your Safety

1. Application

This specification applies to the coin-type MS Lithium Rechargeable Battery, which is manufactured and supplied by Seiko Instruments Inc. to the specified customer in cover page.

2. Model

Model described in cover

3. Chemical System and Structure

Refer to the document "The construction of battery" attached.

4. Nominal Specifications

		Model
No.	Characteristics	MS518SE
4-1	Range of temperature in which it can function	from -20°C to 60°C
4-2	Recommended temperature range for use	from 0°C to 30°C
4-3	Recommended range of preservation temperature and humidity	from 10°C to 30°C 60%RH or less
4-4	Nominal voltage (V)	3
4-5	Charging voltage (V)	from 2.8 to 3.3
4-6	Recommended Charging voltage (V)	3.1
4-7	Maximum Charging Current (mA) At 3V in the battery voltage. At 0V in the battery voltage.	0.2 4
4-8	Nominal capacity(mAh): after charging from 3.0V to 2.0V	3.4
4-9	Standard Discharge Current (mA)	0.01
4-10	Maximum Discharge Current(mA) the half of nominal capacity can be taken out.	0.15
4-11	Nominal dimensions Diameter(mm) Height(mm)	5.8 1.8
4-12	Standard mass(g)	0.13
4-13	Applicable Safety Standard	UL1642 (File MH15628)

■ The "Perchlorate Contamination Prevention Act" in California does not apply to this product."

5. Characteristics

* "Initial" means within one month after deliver.

* Attached "Leakage Criteria" is used for the judgment of leakage.

5-1. Electric characteristics

No.	Characteristics	Model	Test Methods	Measuring Methods
		MS518SE		
1	Open Circuit Voltage(V) at delivery		7-1	6-4
	maximum	3.4		
	minimum	2.6		
2	Open Circuit Voltage(V) after charge		7-1	6-2 1) 6-4
	maximum	3.1		
	Minimum	2.8		
3	Initial Capacity(mAh)		7-2	6-2
	24°C	2.8 or more		
	-20°C	1.5 or more		
	60°C	2.5 or more		
4	Initial Internal impedance(ohm)		7-2	6-3
	24°C	400 or less		
	-20°C	2000 or less		
	60°C	400 or less		

5-2. Mechanical characteristics

No.	Characteristics	Model	Test Methods	Measuring Methods
		MS518SE		
1	Tab Pulling Strength (N): With the terminal		-	6-8
	-	Refer to Battery Drawing with tabs attached		
2	External Appearance		7-1 7-3 7-4	6-9
	Initial	No leakage There must not be foreign body adhesion (over level S2). There is no significant deformation, stain, stricken mark, rust and burr.		
	After Tests	There is no significant leakage (over level C1), deformation, stain, stricken mark, rust and burr.		
3	Free fall	Satisfy initial capacity and internal impedance. There is no significant leakage, deformation, stain, stricken mark, rust and burr, which effect battery performance.	7-8	6-2 6-3 6-9
4	Vibration	Satisfy initial capacity and internal impedance. There is no significant leakage, deformation, stain, stricken mark, rust and burr, which effect battery performance.	7-9	6-2 6-3 6-9

5-3. Reliability

No.	Characteristics	Model	Test Methods	Measuring Methods
		MS518SE		
1	High Temperature Storage Characteristics		7-3	6-2
	Capacity	2.1mAh or more		
2	Float Charge Characteristics		7-4	6-2 6-3
	Capacity	2.2mAh or more		
	Internal impedance	1000ohm or less		
3	Over Discharge Characteristics		7-5	6-2
	Capacity	2.2mAh or more		
4	Charge / Discharge Cycle Characteristics (Cycles)		7-6-1 7-6-2	6-2
	20% D.O.D.	1000 cycles or more		
	100% D.O.D.	100 cycles or more		
5	Leakage Resistance	Level S3 or less (There is no significant leakage which effect battery performance.)	7-7	6-9

5-4. Table of Parameter for Test and Measuring

No.	Characteristics	Model(Type)	Test Methods	Measuring Methods
		MS518SE		
1	Capacity		-	6-2
	Vc(V)	3.1		
	Rp(kohm)	1.0		
	Tc(hrs)	96		
	Rd(kohm)	330		
	Voff(V)	2.0		
2	Float Charge Characteristics		7-4	
	Vc(V)	3.1		
	Rp(kohm)	1.0		
3	Over Discharge Characteristics		7-5	
	Rs (kohm)	22		
4	Charge / Discharge Cycle(20% D.O.D)		7-6-1	
	Vc(V)	3.1		
	Rp(kohm)	1.0		
	Tcs(hrs)	10		
	Rds(kohm)	18		
	Tds(hours)	3.8		
5	Charge / Discharge Cycle(100% D.O.D)		7-6-2	
	Vc(V)	3.1		
	Rp(kohm)	1.0		
	Tcd(hrs)	48		
	Rdd(kohm)	18		
	Tdd(hours)	20		

6. Measuring Methods

6-1. General Conditions

The measuring conditions are temperature of 24+/-2 °C, humidity of 65+/-20%Rh and within one month after delivering, if not specified.

6-2. Capacity

- 1) Charging: Apply specified voltage (V_c) through the protective resistance (R_p) for specified time (T_c).
- 2) Discharging: Discharging with load resistance (R_d) until the cell voltage reaches the cut off voltage (V_{off}), the cell voltage (V_i) and time (T_i) should be measured at intervals within one hour.
- 3) Calculation: The capacity value is calculated by the expression below.

$$Capacity = \sum_i \left(\frac{(V_i + V_{i+1})}{2} \times \frac{1}{R_d} \times (T_{i+1} - T_i) \right)$$

- 4) General Circuit: The circuit, for charging and discharging, is shown as follows.

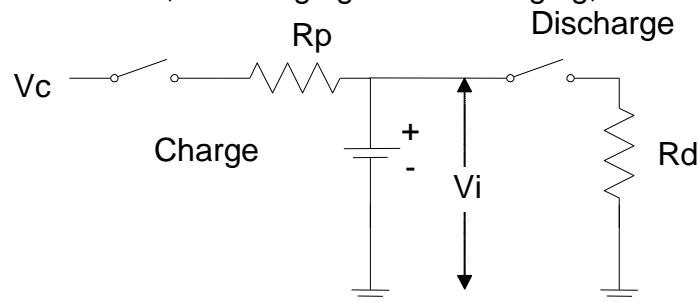

6-3. Internal Impedance

Measure by alternating current method using frequency of 1kHz.

6-4. Voltage

Use a direct current voltage meter, which has input impedance of 10Mohm or more and accuracy of +/-0.2% or less.

6-5. Current

Use an ammeter with accuracy of +/-0.2% or less.

6-6. Resistance

Resistance, which includes resistance of all external circuits, requires accuracy of 2.0% or less.

6-7. Size measurement

Use the size measurement instruments with accuracy of 0.01mm or 0.001mm if necessary.

6-8. Terminal pull strength: The direction of the pull is vertical.

Use a digital force gauge, which has accuracy of +/-1.0% or less.

6-9. Appearance

- | | |
|-------------|--|
| After Test | : Microscope, which has magnification of 10 times. |
| At delivery | : Naked eye |

7. Test Methods

7-1. General conditions

The test conditions are temperature of 24 ± 2 °C, humidity of $65\pm 20\%$ Rh and within one month after delivering, if not specified.

7-2. Temperature Characteristics Test

Measure electrical characteristics after exposing battery to each temperature atmosphere for 2 hours.

Temperature: -20 ± 2 °C, $+24\pm 2$ °C, $+60\pm 2$ °C

7-3. High Temperature Storage

After Charging at voltage of V_c through protective resistance of R_p for T_c hours, store battery at temperature 60 ± 2 °C for 20days.

7-4. Float Charge Characteristics Test

Charge battery at voltage of V_c through protective resistance of R_p at temperature of 60 ± 2 °C for 20days.

7-5. Over Discharge Characteristics Test

Discharge the battery by discharge resistance of R_s for 30 days.

7-6. Charge / Discharge Cycle Characteristics Test

7-6-1. Shallow Discharge cycle characteristics (20% Depth of discharge)

Charge : Apply specified voltage (V_c) through protective resistance (R_p) for specified period (T_{cs}).

Discharge : With load resistance (R_{ds}) for specified period (T_{ds}).

Life : Let the time of putting on measurement of 6-2 and becoming 50% of a initial capacity standard value be a life.

7-6-2. Deep Discharge cycle characteristics (100% Depth of discharge)

Charge : Apply specified voltage (V_c) through protective resistance (R_p) for specified period (T_{cd}).

Discharge : With load resistance (R_{dd}), for specified time (T_{dd}) or until the cell voltage reaches 2.0V.

Life : Let the time of putting on measurement of 6-2 and becoming 50% of a initial capacity standard value be a life.

7-7. Leakage Resistance (Thermal Shock Test: Air to Air)

Hold battery at -10 ± 2 °C for 1 hour then hold it at 60 ± 2 °C for 1 hour.

Repeat 100 cycles between above conditions. (Chamber) Not humidity controlled.

7-8. Free Fall Test

Drop the battery ten times in an arbitrary direction on the board of the oak of 3cm in thickness from the height of 75cm. The tabs of battery should be cut before test.

7-9. Vibration Test

Vibrate the battery in the direction of 3(x, y, z) for 30 minutes by 1000 cycles per minute with amplitude of 2mm. The tabs of battery should be cut before test.

8. Mounting Condition

8-1. For soldering iron

Use the conditions as follows

	Model
	MS518SE
Temperature	350 °C or less
Soldering time	Within five seconds

Within above conditions, do not heat battery over 85°C.

Do not solder directly to the battery.

8-2. Dip soldering

Not applicable

8-3. Reflow soldering

Not applicable

9. Indications (Markings)

9-1. Dies

Following items are indicated on battery.

Below items can be omitted except item (2).

(1) Model code

(2) Cathode polarity (+)

(3) Manufacturer's name or monogram

(4) Country of origin

9-2. Date of Manufacturing

Date of Manufacturing is marked on the positive tab or the battery (if possible) and label of each package as.

(Example) 51**...manufactured in January 2015
 6Y**...manufactured in November 2016
 70**...manufactured in October 2017

Abbreviation of month: Jan. (1), Feb. (2).... Sep. (9), Oct. (0), Nov. (Y), Dec. (Z)

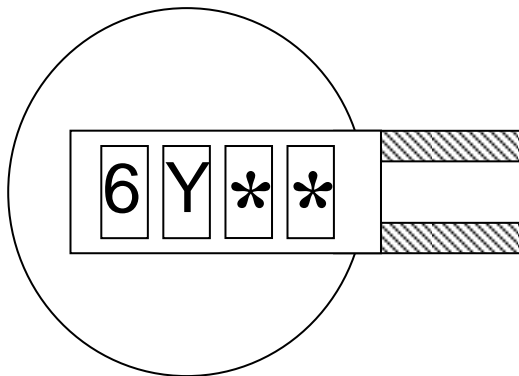

Date of manufacturing is positioned at random.

**is our own number, might be omitted.

Method of marking of manufacturing date is laser type.

10. Inspection

The customer should do incoming inspection within 30 days from receiving day. If defective products are found at incoming inspection, the customer immediately should notify to Seiko Instruments Inc. in writing with the defective products for replacement request. When there was no connection from you within 30 days, we shall judge that those were accepted.

11. Package Specifications

Examples of the tray for wrapping, wrapping specification, and packing specification are shown in the following.

11-1. The tray for wrapping

Refer to "Drawing of tray".

The positive electrode can of the battery stored in the tray is upward.

11-2. Wrapping and packing

Refer to "Package specifications".

12. In case of performance trouble

The warranties set forth herein are the only warranties on the products.

The liabilities of Seiko Instruments Inc. in connection with the products under these specifications are expressly limited to the replacement of defective products.

13. Operation of Specifications

13-1. Agreement

Before these specifications being revised, the agreement, of the customer, seller and manufacturer, is required.

13-2. Negotiation

If some accident not specified on these specifications occurs, the customer, seller and manufacturer must negotiate in order to solve the problem faithfully.

Leakage Criteria 漏液外觀基準

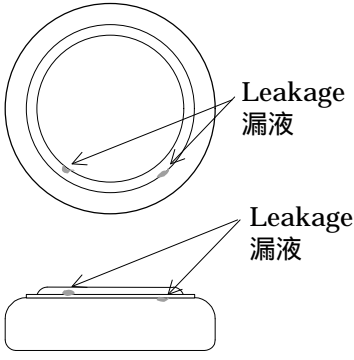
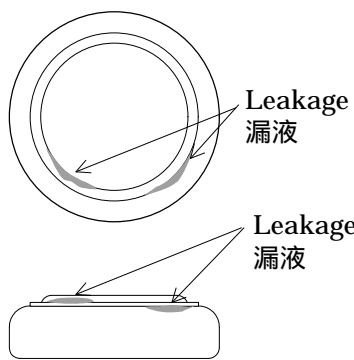
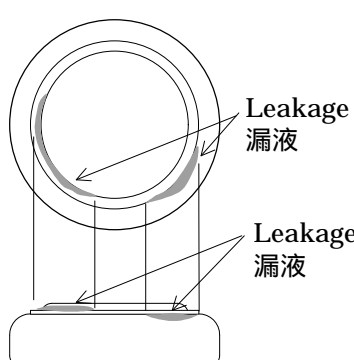
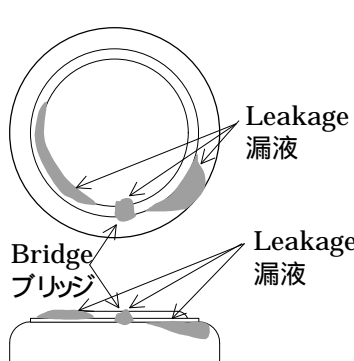
Grade 級	Criteria 外觀基準	
	Diagram 図	Definition 定義
S1		<p>The leakage can not be seen by naked eyes, but can be seen by microscope, which have magnification of 10 to 15. 肉視で判別不可 顕微鏡（10～15倍）で判別可能なもの</p>
S2		<p>The leakage can be seen by naked eyes. The area of leakage is within half of the round and reaching to neither the flat area of the negative can nor the straight area of the positive can. The leakage is not bridged between the negative can and the positive can. 肉視で判別可能なもの。円周 1/2 まで R 部を超えないこと ブリッジ（正極缶と負極缶）のないこと</p>
S3		<p>The area of leakage is from half to all of the round and reaching to neither the flat area of the negative can nor the straight area of the positive can. The leakage is not bridged between the negative can and the positive can. 円周 1/2 ～全周 R 部を超えないこと ブリッジ（正極缶と負極缶）のないこと</p>
C1		<p>The area of leakage is reaching to either the flat area of the negative can or the straight area of the positive can. The leakage is bridged between the negative can and the positive can. R 部を超えたもの 負極缶のフラット部まで到達 正極缶のストレート部まで到達 ブリッジ（正極缶と負極缶）のあるもの</p>

②負極 Negative electrode
(リチウム-シリコン)複合酸化物
Lithium-Silicon composite oxide)

③セパレータ Separator

①負極缶 Negative electrode can
(ニッケルメッキ付ステンレスチール
Nickel plated stainless steel)

⑥電解液 Electrolyte
(有機電解液 Organic electrolyte)

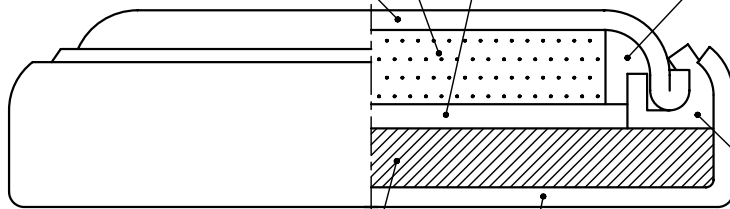

⑤正極 Positive electrode
(リチウム-マンガ)複合酸化物
Lithium-Manganese composite oxide)

④ガスケット Gasket
(ポリプロピレン Polypropylene)

⑦正極缶 Positive electrode can
(ニッケルメッキ付ステンレスチール
Nickel plated stainless steel)

				File No. 文件番号	30460000-MSFEO-2
				Material 材料	
				Process 処理	
E11B-003	Jan. 11, 2011	MS***GE追加		Date 日付	Jun. 24, 2008
E08A-019	Jun. 24, 2008	設定		Name 名称	Construction of battery 電池構成図
History 履歴	Date 日付	Reason 理由			
Approved 承認	Checked 検査	Drawn 製図	Scale 尺度	Cal. No. 製品番号	MS***FE,, MS***SE, MS***GE
篠田	鈴木	小関	Unit 単位	1=1mm	Drw. No. 図面番号
			Rev. 改訂	2	

(NOTES) 1. TAB pulling strength : Over 9.8N(1.0kgf)
 (注) 1. 端子引張強度 : 9.8N(1.0kgf) 以上

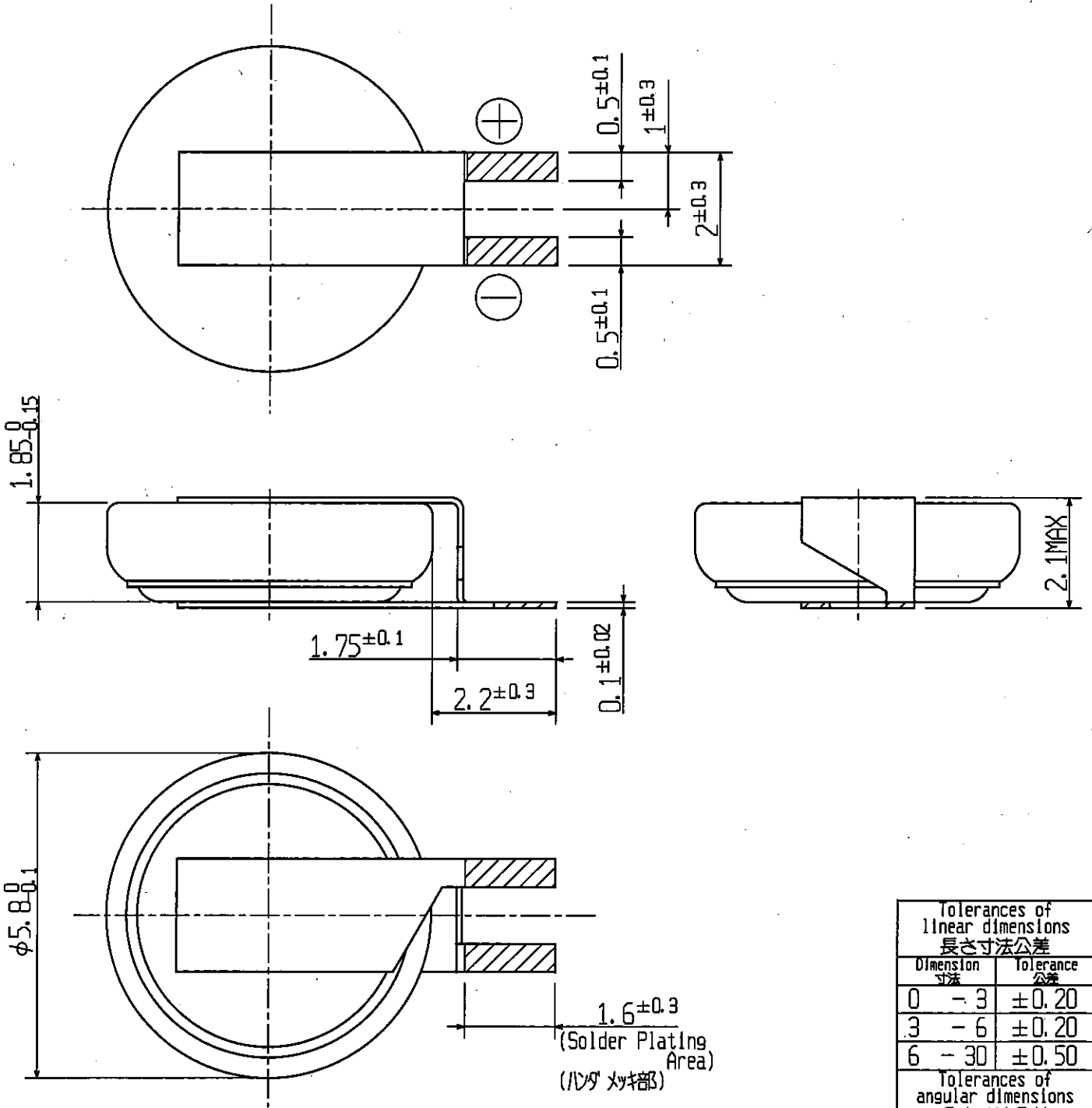

Tolerances of linear dimensions 長さ寸法公差		
Dimension 寸法		Tolerance 公差
0 - 3		±0.20
3 - 6		±0.20
6 - 30		±0.50
Tolerances of angular dimensions 角度寸法公差		
±2°		

				File No. 部品番号	3046E380-FL35E-1
				Material 材料	TAB: SUS304-NI·P H/2
				Process 処理	▨ : Solder plating ハンダメッキ 2~4μm (Sn 100%)
				Date 日付	Jan. 12. '07
EO7A-004 Jan. 12. '07 設定				Name 名称	Battery drawing with tabs 端子付電池図面
History 履歴		Date 日付		Reason 理由	
Approved 承認	Checked 検査	Drawn 製図	Scale 尺度	10:1	Cal. No. 製品番号 MS518SE FL35E
冨塚	鈴木	三浦	Unit 単位	1=1mm	
				Rev. 改訂	1
				Draw. No. 図面番号	E38 FL35E

Seiko Instruments Inc.

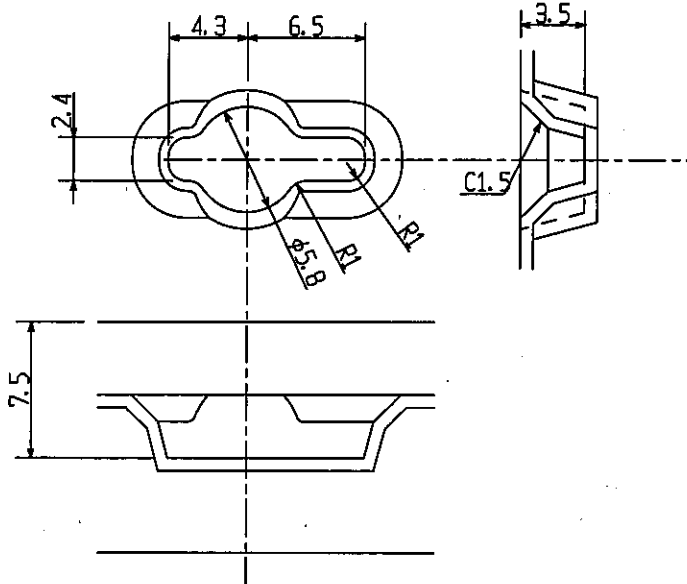
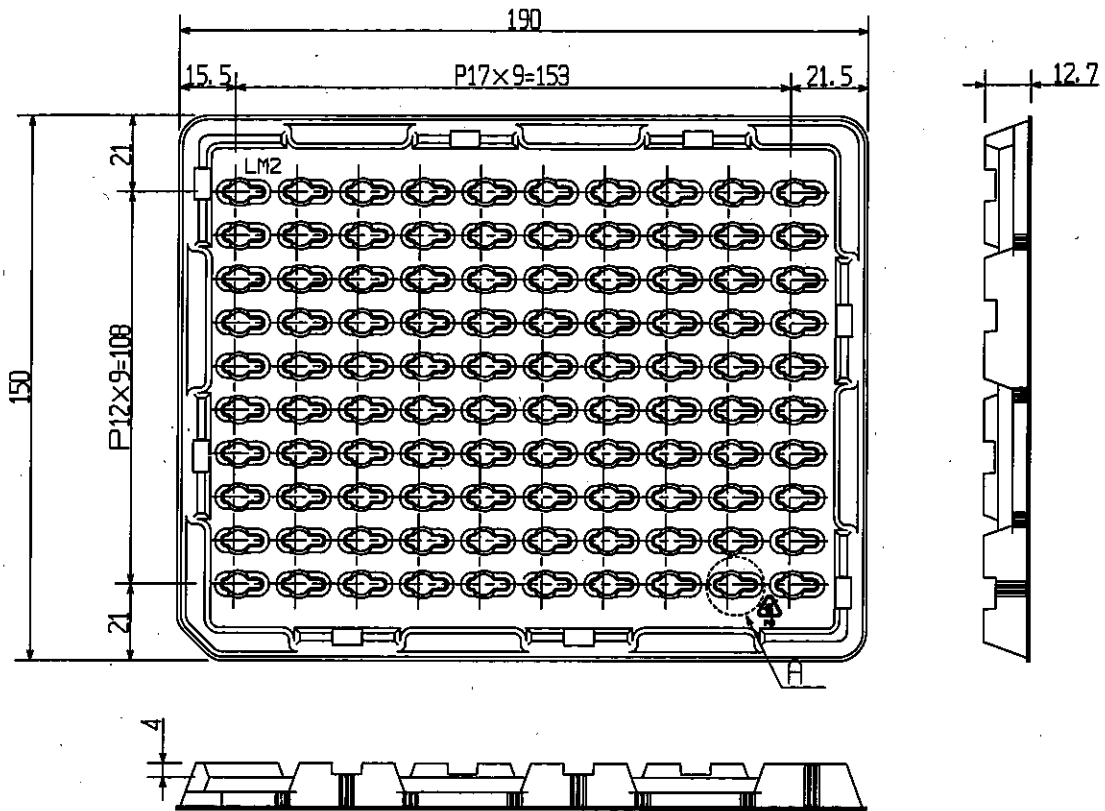

Detail A (5:1)
詳細 A (5:1)

Tolerances of linear dimensions 長さ寸法公差	
Dimension 寸法	Tolerance 公差
$L \leq 10$	± 0.50
$10 < L < 60$	± 0.80
$60 < L < 100$	± 1.00
$100 \leq L$	± 1.50
Tolerances of angular dimensions 角度寸法公差	
$\pm 2^\circ$	

				File No. 7711番号	31760000-LM020A1
				Material 材料	Polystyren ポリスチレン
				Process 処理	
				Date 日付	Oct. 03. '06
ED6A-019	Oct. 03. '06	設定		Name 名称	Drawing of tray
History 履歴	Date 日付	Reason 理由			N-図
Approved 承認	Checked 検査	Drawn 製図	Scale 尺度	Cal. No. 製品番号	LM2 tray
富塚	尾形	穴戸	Unit 単位	1:2	LM2 N-
				1=1mm	
			Rev. 改訂	1	Drw. No. 図面番号

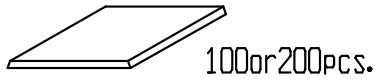

100or200pcs.

100 or 200pcs. In a tray
100又は200個入り トレイ

Label: Model, lot number, quantity, remarks
ラベル: 製品名, Lot No, 数量, 備考

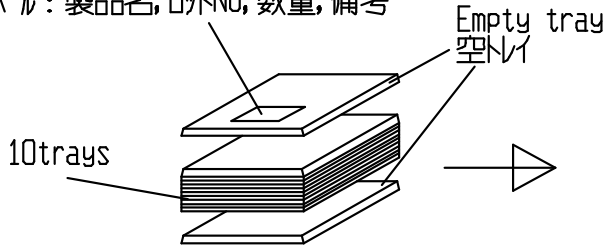

10trays

Plastic film
ポリフィルム

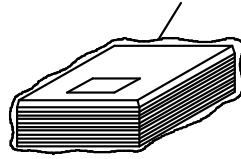

10 trays in plastic film pack
10 トレイ ポリパック

Max 16000pcs. In carton
最大16000個入りカートン

Battery size 電池サイズ	Battery quantity/Tray 電池数量/トレイ	Battery quantity/Pack 電池数量/パック	Maximum packing quantity/Tray 最大パック数量/箱	Maximum battery quantity/Tray 最大電池数量/箱
412	200	2,000	8	16,000
414	200	2,000	8	16,000
518	100	1,000	8	8,000
614	100	1,000	8	8,000
621	100	1,000	8	8,000
920	100	1,000	4	4,000

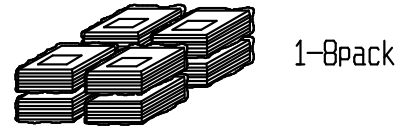

1-8pack

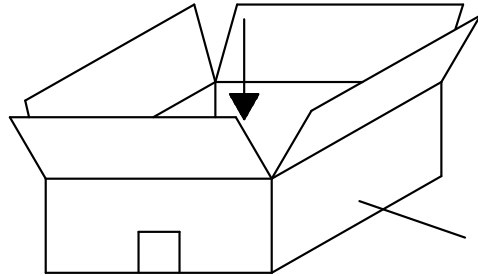

Carton
段ボール箱

Product mass: MAX 2.5kg
製品質量 : 最大2.5kg

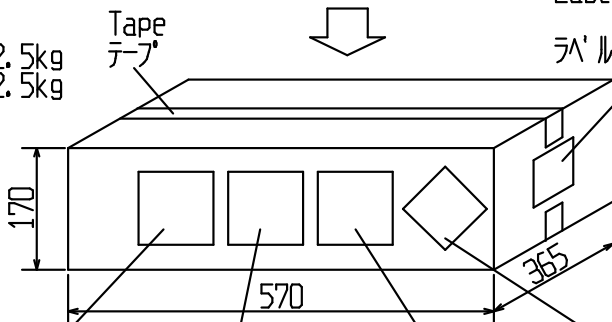

Tape
テープ

Label: Model, Quantity, Delivery date,
Purchase order number etc.
ラベル: 製品名, 納入数量, 納入月日, 注番 等

Package appearance
梱包外観



Risk Information Label
危険性情報ラベル



Lithium metal battery Label
リチウム電池ラベル



CARGO AIRCRAFT ONLY Label
航空貨物専用ラベル



Class 9 Label
クラス9ラベル

The above packaging specifications are standard.
These specifications vary with the quantity to be supplied.
上記、梱包形態は標準的なもので、納入時の数量により異なります。

E18B-007	Jul, 26, 2018	リチウム電池ラベル、クラスラベル変更			File No. ラベル番号	31760A76-000T1B2
E16B-008	Sep. 13, 2016	電池サイズによる数量記載			Date 日付	Aug, 23, 2016
E16A-009	Aug. 23, 2016	設定			Name 名称	Package specifications(Section I B) 梱包仕様(Section I B)
History履歴	Date 日付	Reason 理由			Cal. No. 製品番号	A76T01B
Approved 承認	Checked 検査	Drawn 製図	Scale 尺度	Unit 単位	Draw. No. 図面番号	3176 0A76T1B
尾形	佐藤(涼)	高野	1=1mm	3		
			Rev. 改訂	3		

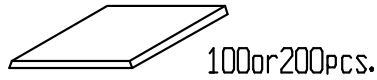

100or200pcs.

100 or 200pcs. In a tray
100又は200個入り トレイ

Label: Model, lot number, quantity, remarks
ラベル: 製品名, ロットNo, 数量, 備考

10trays

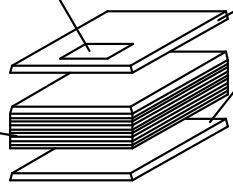

Empty tray
空トレイ

Plastic film
ポリフィルム

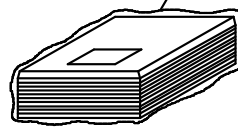

10 trays in plastic film pack
10 トレイ ポリパック

Max 16000pcs. In carton
最大16000個入りカートン



Battery size 電池サイズ	Battery quantity/Tray 電池数量/トレイ	Battery quantity/Pack 電池数量/パック	Maximum packing quantity/ Carton 最大パック数量/箱	Maximum battery quantity/ Carton 最大電池数量/箱
412	200	2,000	8	16,000
414	200	2,000	8	16,000
518	100	1,000	8	8,000
614	100	1,000	8	8,000
621	100	1,000	8	8,000
920	100	1,000	4	4,000



1-8pack

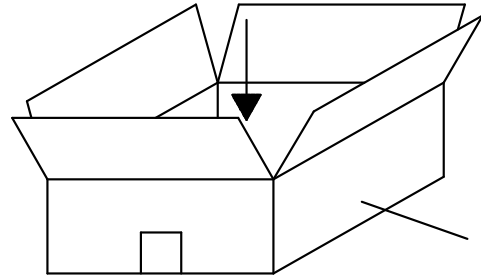

Carton
段ボール箱

Product mass: MAX 2.5kg
製品質量 : 最大2.5kg

Tape
テープ

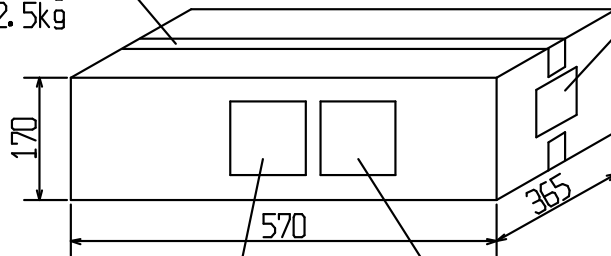

Label: Model, Quantity, Delivery date, Purchase order number etc.
ラベル: 製品名, 納入数量, 納入月日, 注番 等

Package appearance
梱包外観



Lithium metal battery Label
リチウム電池ラベル



CARGO AIRCRAFT ONLY Label
航空貨物専用ラベル

The above packaging specifications are standard.
These specifications vary with the quantity to be supplied.
上記、梱包形態は標準的なもので、納入時の数量により異なります。

E18B-007	Jul. 26, 2018	リチウム電池ラベル変更			File No. ラベル番号	31760A76-000T2-2	
E16B-008	Sep. 13, 2016	電池サイズによる数量記載			Date 日付	Aug, 23, 2016	
E16A-009	Aug. 23, 2016	設定			Name 名称	Package specifications (Section II) 梱包仕様 (Section II)	
History 履歴	Date 日付	Reason 理由					
Approved 承認	Checked 検査	Drawn 製図	Scale 尺度		Cal. No. 製品番号	A76T02	
尾形	佐藤 (涼)	高野	Unit 単位	1=1mm	Draw. No. 図面番号	3176 0A76T02	
			Rev. 改訂	3			

Seiko Instruments Inc. Micro-Energy Division

Precautions for Your Safety

SII Lithium rechargeable batteries (MS, ML, TS) contain flammable organic solvents. For your safety, please follow following prohibitions.

WARNING!

- 1. Do not charge by high current or high voltage.**
Doing so may generate gas inside the battery, resulting swelling, fire, and heat generation or bursting.
- 2. Do not heat, disassemble nor dispose of in fire**
Doing so damages the insulation materials and may cause catching fire, heat generation, leakage or bursting.
- 3. Do not solder directly to the battery**
If soldering is performed directly to the battery, the battery is heated up, consequently cause leakage, explosion or fire due to overheating from internal short-circuit.
- 4. Do not short.**
If the (+) and (-) come into contact with metal materials, short-circuit occurs. As a result, fire, heat generation, leakage or bursting may occur.
- 5. Keep batteries out of children's reach.**
It is dangerous that children swallow the battery.
When you design mechanical hardware around the battery, please fix the battery firmly in order to prevent children from removing it.
When you store the batteries, please keep the batteries out of children's reach.
If a battery is swallowed, consult a physician immediately.
- 6. Do not reverse placement of (+) and (-)**
If the (+) and (-) side of the battery is reverse inserted, it may cause a short-circuit or over discharge of the battery on some equipment and it may induce overheating, explosion or fire.
- 7. Do not weld terminals to the battery**
The heat by welding may cause fire, heat generation, leakage or bursting.
We weld standard terminals under strictly controlled conditions.
If you need to weld terminals to the battery, please consult us in advance.
- 8. Do not discharge by force**
If the battery is discharged by direct connection to an external power supply etc., voltage of the battery will decline lower than 0 volts (electrical reversal) and will cause the battery case to expand, overheat, leak, explode or burn.
- 9. In case of leakage or a strange-smell; keep away from fire to prevent ignition of any leaked electrolyte.**
- 10. In case of disposal, insulate between (+) and (-) of battery by an insulating material.**
Jumbling batteries or with other metal materials cause short-circuiting. As a result, fire, heat generation, leakage or bursting may occur.

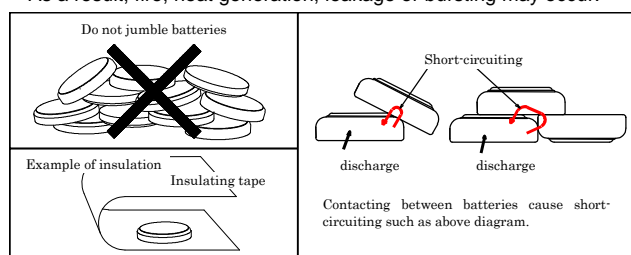

CAUTION!

- 1. If leaked liquids gets in the eyes, wash them with clean water and consult a physician immediately.**
- 2. Do not use new and used batteries together. Do not use different types of batteries together.**
It may cause fire, heat generation, leakage or bursting.
- 3. If you connect two or more batteries in series or parallel, please consult us in advance.**
It may cause bursting or fire due to unbalanced load or voltage.
- 4. Do not use nor leave the batteries in direct sunlight, nor in high-temperature areas.**
It may cause fire, heat generation, leakage or bursting.
- 5. Do not apply strong pressure to the batteries nor handle roughly.**
It may cause fire, heat generation, leakage or bursting.
- 6. Avoid contact with water.**
It may cause heat generation.
- 7. Keep batteries away from direct sunlight, high temperature and humidity.**
It may cause heat generation or performance deterioration.
- 8. Do not make batteries airtight by sealing it with adhesive agent or coating agent.**
It may cause short-circuit because of generated and accumulated electrolyte gas.

For prevention the performance of battery

- 1. Pay attention to mat or sheet for ESD**
Battery with tabs or battery on PCB may short circuit on the mat for ESD. As a result, the voltage of the cell is reduced.
- 2. Pay attention to soldering by iron tips**
Do not touch the battery by soldering iron tips directly.
Keep any high temperature process away from battery.
- 3. Pay attention to material of jig for pick and place**
Use non-conductive material of jig for pick and place of batteries in order to prevent short-circuit. If short circuit of battery is occurred, the voltage of battery drops down quickly but raises gradually.
- 4. Pay attention to washing and drying**
Some detergent or high temperature drying cause deteriorates of battery. If you need to wash batteries, consult us.

International Transportation and Disposal

International Air / Marine / Ground Transportation

Regarding the transport of Lithium battery, organizations like IATA, ICAO, IMO, DOT have determined transport regulations, based on the United Nations Regulations.

Regarding air transport, SII Lithium rechargeable batteries can be transported being not subject to the provisions of dangerous goods, if the transportations meet the following requirements.

Please contact us for more details.

Regarding marine or ground transport, please contact us for more details, too.

(a) <Strong Packaging> Batteries are separated each other, and are packed in strong packaging so as to prevent short-circuit.

(b) <Caution Label> Lithium battery handling label (IATA prescribed), indicating that the packages contain Lithium batteries, that the packages must be handled with care, and that special procedures should be followed in the event that the package is damaged, and a telephone number for additional information, must be put on each package.

(c) <CAO Label> "CARGO AIRCRAFT ONLY" Label must be put on each package.

(d) <Not Restricted Declaration> Each shipment must be accompanied with a document indicating that the packages contain Lithium batteries, that the packages must be handled with care, that it must not be transported by

passenger flight, and that special procedures should be followed in the event that the package is damaged, and a telephone number for additional information.

(e) <Package Drop Test> Each package is capable of withstanding a 1.2m drop test in any orientation without damage to batteries contained.

(f) <Weight Limit> Net weight of one package may not exceed 2.5 kg.

(g) <One carton per one shipment> The shipment must be "one carton per one shipment" to be shipped as "Non-dangerous goods".
"One shipment" means one airway bill = one invoice.

【Transport as dangerous goods】

When you transport SII's Lithium rechargeable batteries by "more than one carton per one shipment", you will have to arrange it as "Dangerous goods". It requires special procedures, like "Class 9 dangerous goods Label" on carton, and "dangerous goods declaration".

Disposal

Recently environmental protection regulations have increased and battery disposals are regulated globally.

Such regulations are different in each country, state, and municipality.

Please consult your local authorities regarding the specific regulations in your area.